

PLEASE READ THE INSTRUCTIONS BEFORE OPERATING THIS PRODUCT

OPERATION INSTRUCTIONS

OPERATING YOUR BLIND

TO RAISE & LOWER THE BLIND

Simply raise and lower the blind to the desired position by firmly holding the thumb tab. Slats need to be open when raising or lowering the blind.

SLAT ANGLE

To adjust the angle of the slats, twist the wand.

MAINTENANCE

The product is maintenance free however we recommend that regular visual checks are completed to ensure that no components have been damaged, which could result in operating difficulties and/or cause a safety risk.

If any maintenance is required we recommend that the work is carried out immediately, by a reputable blind company.



make it safe™



WARNING

Young children can be strangled by loops in pull cords, chains, tapes and inner cords that operate the product.

To avoid strangulation and entanglement, keep cords out of the reach of young children. Cords may become wrapped around a child's neck. Move beds, cots and furniture away from window covering cords.

Do not tie cords together. Make sure cords do not twist and create a loop.

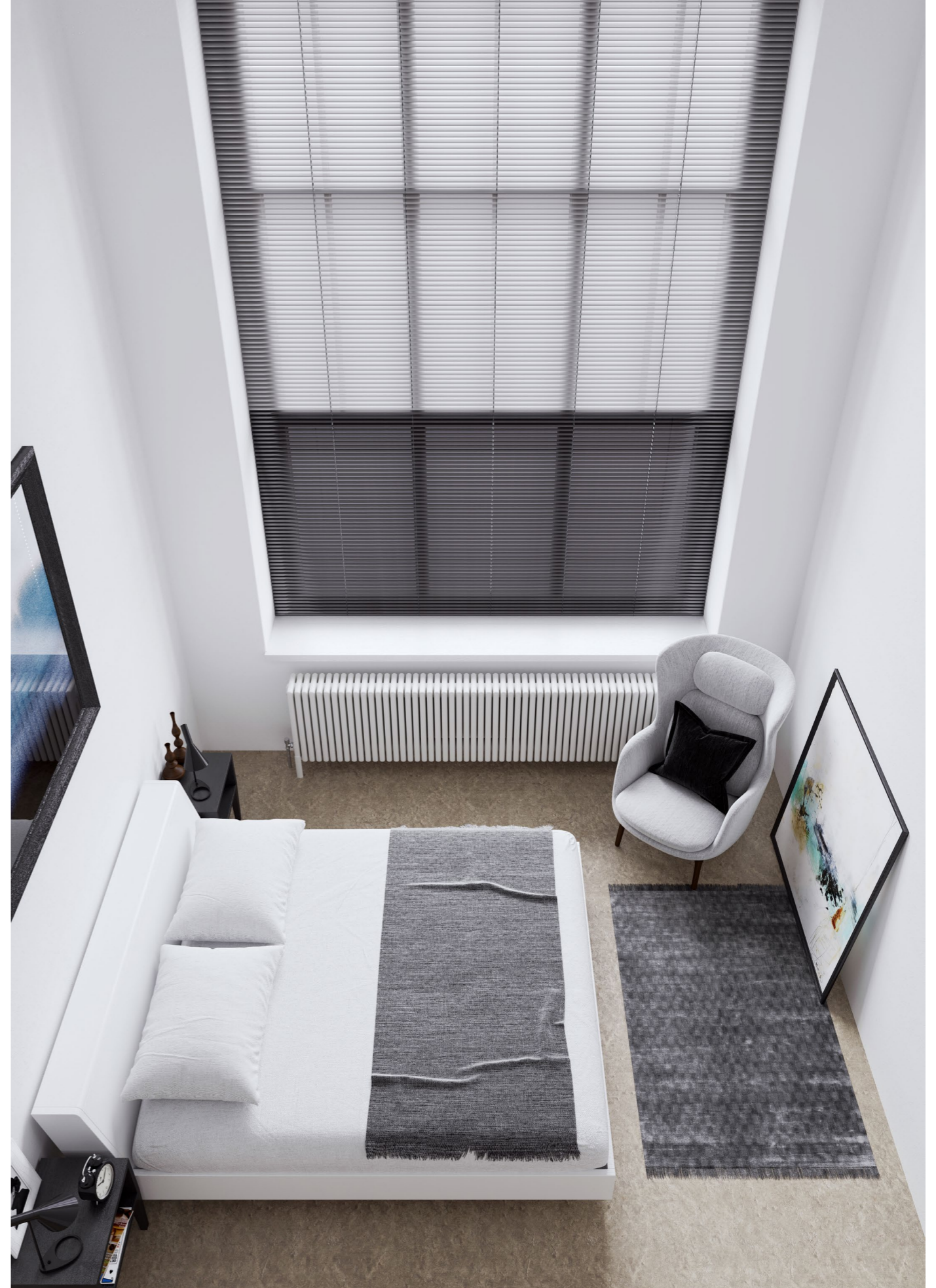
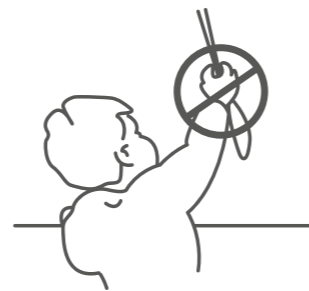

Perfect Fit Tensioned Blinds

YOU SHOULD HAVE

PERFECT FIT ITEM LIST

Perfect Fit frame and blind

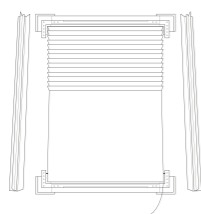

4 x Corner caps

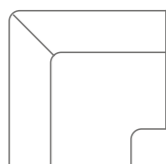

Brackets
(amount to suit size of blind)

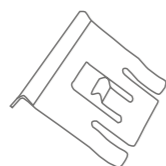

12 x Cover Cap & frame screws



TOOLS REQUIRED

Screwdriver

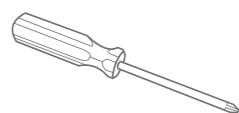

NOTE: for blinds with frame, the wand will always be attached to the back of the side sections of the frame. For blinds without a frame, the wand will be inside the head rail of the blind.
Sunwood: when the wand is wider than the blind, the wand will be sent as a separate package.

THE INSTALLATION OF THIS PRODUCT SHOULD BE CONDUCTED BY SOMEONE COMPETENT IN DIY.

STEP 1

PUT THE FRAME TOGETHER

1.1

Lay all parts of the frame/blind out face down on a clean even surface. Next unwrap the cords

Your blind will be attached to the top and bottom parts of the frame by side guide cords.

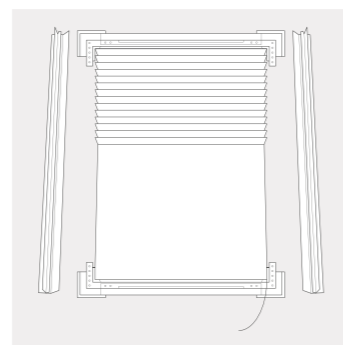

1.2

Connect the left-hand side of the frame to the exposed arm on the bottom left-hand corner joint until it feels secure. Repeat the process on the top left-hand corner joint.

Follow the same procedure for the right-hand side of the frame.

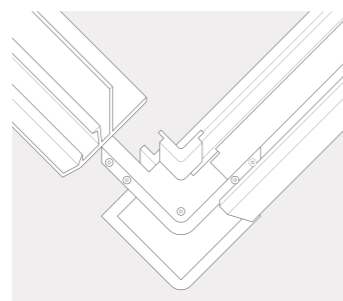

1.3

Your Perfect Fit frame and blind are ready to fit.

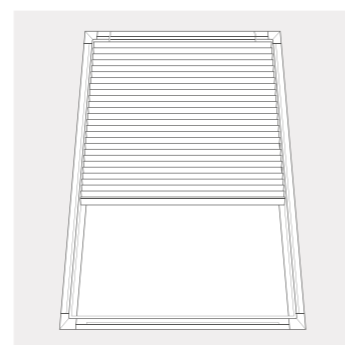

Attach the hook onto the spring. Test operation of blind. If the tension needs to be adjusted, loosen the screw in the locking ring. To increase tension make the cord shorter. To reduce tension make the cord longer and tighten the screw in the locking ring.

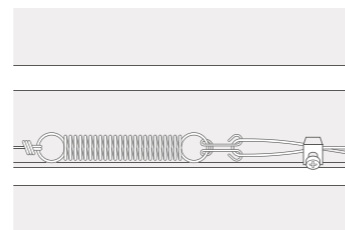

STEP 2

ATTACH THE BRACKETS

2.1

You need to push the brackets between your window pane and the rubber window seal.

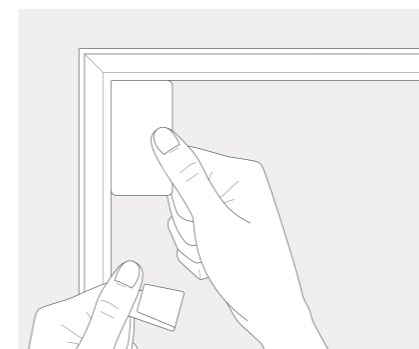

TIP: You can use a credit/debit card as a template to find the correct position for the brackets. Place the card length ways along the side of the window in each corner, and line up the bracket with the end of the card as shown.

2.2

Fit any intermediate brackets accordingly. Two extra brackets will be supplied for blinds over 110cm drop, these should be positioned approx mid way down the drop of the blind one on each side. These need to be lined up with the bracket hole positions on the Perfect Fit frame.

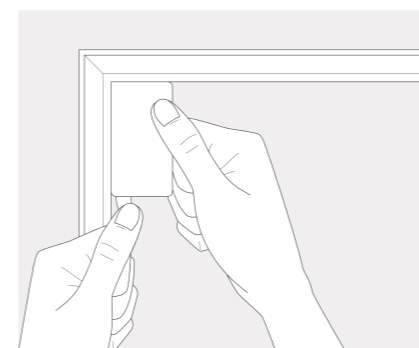

TIP: If you find that the brackets are difficult to place behind the window seal, you can use a some washing up liquid as lubricant on the flat part of the bracket. Once all the brackets are fitted, clean any excess from the window surface.

STEP 3

ATTACH THE FRAME & BLIND TO THE WINDOW

3.1

Line up the holes in the Perfect Fit frame with the brackets.

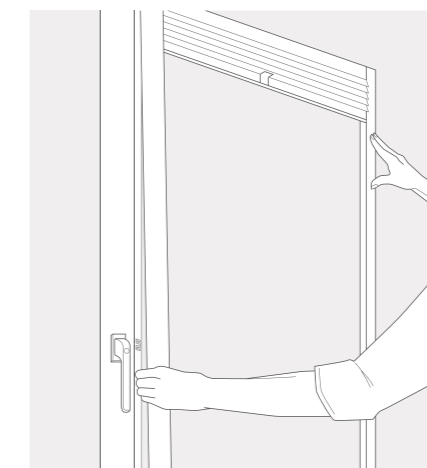

3.2

Firmly press the frame onto each bracket one side at a time.

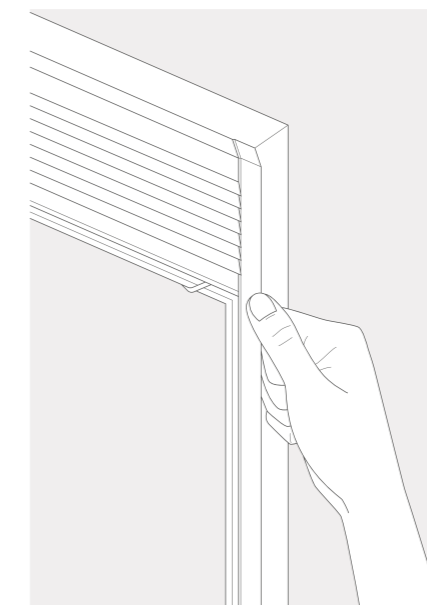

Your frame and blind are now installed.